

 CARATTERISTICHE TECNICHE
 TECHNICAL CHARACTERISTICS
 DONNEES TECHNIQUES
 TECHNISCHE DATEN

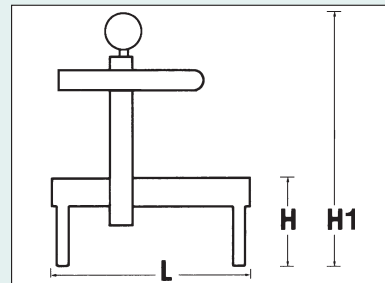

L = 1730 mm
 H = 500 ÷ 800 mm
 H1 = 1650 ÷ 1900 mm
 W = 1000 mm

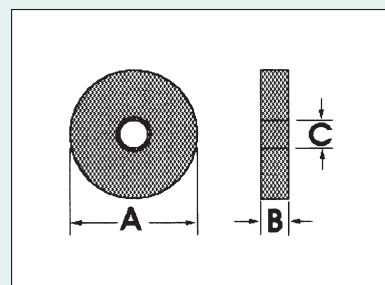

A = 300 mm MAX
 B = 50 mm (STANDARD)
 C = 76 mm

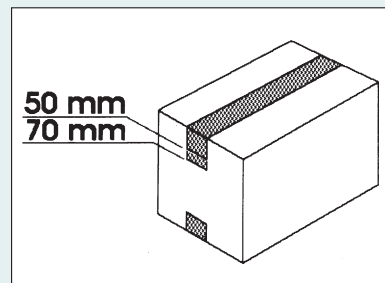

PRESS: 6 BAR
 (5 lt./BOX)





OPTIONAL

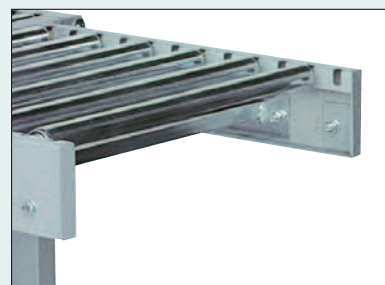

SET RUOTE CON FRENO
 SET OF CASTERS WITH BRAKE
 ROUES AVEC FREIN
 RÄDER MIT BREMSE



PIANO A RULLI A GRAVITÀ
 GRAVITY ROLLER CONVEYORS
 CONVOYEURS À GRAVITÉ
 ROLLENBAHNEN

 FILMA È ANCHE:
 FILMA IS ALSO:
 FILMA EST AUSSI:
 FILMA IST AUCH:



RULLIERE ESTENSIBILI
 EXTENSIBLE AND FLEXIBLE CONVEYORS
 CONVOYEURS EXTENSIBLES ET FLEXIBLES
 AUSZIEHBARE BAHNEN



TRASPORTATORI A TAPPETO
 MOTORIZED BELT CONVEYORS
 CONVOYEURS MOTORISÉS À TAPIS
 ANGETRIEBENEN FÖRDERBAHNEN



RULLIERE MOTORIZZATE
 MOTORIZED ROLLERS CONVEYORS
 CONVOYEURS MOTORISÉS À ROULEAUX
 ANGETRIEBENEN ROLLENBAHNEN



FASCIAPALLET
 PALLET WRAPPING MACHINES
 MACHINES À BANDEROLER
 STRETCHFOLIENWICKELMASCHINEN



ROBOT FASCIAPALLET
 ROBOT PALLET WRAPPER
 ROBOT DE BANDEROLAGE
 STRETCHWICKELROBOTER







FILMA
 PACKAGING MACHINES

... the never ending story ...







SC1/500-MF

 NASTRATRICE AUTOMATICA FORMATO FISSO CON CHIUDIFALDE
 AUTOMATIC CARTON SEALING MACHINE FOR UNIFORM SIZED CARTONS, WITH AUTOMATIC CLOSING FLAPS
 MACHINE POUR LA FERMETURE AUTOMATIQUE DES CARTONS A REGLAGE MANUEL AVEC UNITE DE FERME-RABAT
 AUTOMATISCHE KARTONVERSCHLISSMASCHINE MIT MANUELLER FORMATEINSTELLUNG UND MIT SEITE KARTONS SCHUAPPVERSCHLUB



SC1/500-MF

-  NASTRATRICE AUTOMATICA FORMATO FISSO CON CHIUDIFALDE
-  AUTOMATIC CARTON SEALING MACHINE FOR UNIFORM SIZED CARTONS, WITH AUTOMATIC CLOSING FLAPS
-  MACHINE POUR LA FERMETURE AUTOMATIQUE DES CARTONS A REGLAGE MANUEL AVEC UNITE DE FERME-RABAT
-  AUTOMATISCHE KARTONVERSCHLISSMASCHINE MIT MANUELLER FORMATEINSTELLUNG UND MIT SEITE KARTONS SCHUAPPVERSCHLUB

Funzionamento: Le due teste nastranti applicano contemporaneamente una striscia di nastro adesivo sopra e sotto la scatola. Ideale per chiudere scatole a formato fisso (con altezza e larghezza costanti). La scatola deve arrivare sul piano di lavoro con le falde superiori aperte e il chiudifalde provvede a chiuderle automaticamente. Per il cambio formato si effettuano due semplici regolazioni.

Function: The simultaneous sealing of the top and bottom flaps of the carton is guaranteed through the two taping heads. The carton-box must arrive on the workin height with the opened top flaps and then the machine will close them automatically. The ideal solution for uniform sized boxes. A new carton dimension requires only two simple and easy adjustments.

Fonctionnement: La fermeture simultanée du dessus et du dessous de la boîte est garantie par la pose d'une bande de ruban adhésif sur chaque côté. La boîte doit arriver sur le plan de travail avec le dessus ouvertes, et après la machine les fermera automatiquement. La solution idéale pour des séries de cartons avec le même format. Le changement du format des boîtes demande deux réglages simples et rapides.

Funktion: Es verschliesst in einem Arbeitsgang die unterere und obere Seite des Kartons mit selbstklebendem Klebeband. Die Karton mußt an die arbeite flache kommen mit die obere seiten offen, dann kent die maschine automatische die obere seiten schlossen. Die ideale Lösung zum serienweisen Verschluss von Kartons gleicher Größe. Eine neue Kartongröße verlangt nur zwei einfach und schnelle Handeinstellungen.



UNITÀ DI TRASCINAMENTO
SCATOLA (H. 70 MM -
VELOCITÀ 21 MT/MIN)

DRIVING BELTS (70 MM
HIGH - WORKING SPEED
OF 21 MT/MIN)

COURROIES
D'ENTRAÎNEMENT
(HAUTEUR 70 MM -
VITESSE DE 21 MT/MIN)

ANTRIEBSBÄNDER
(HÖHE 70 MM -
GESCHWINDIGKEIT
21 MT/MIN)



UL-50 UNITÀ NASTRANTE
(STANDARD PER NASTRO
LARGHEZZA MM 50)

UL-50 TAPING HEAD,
50 MM. WIDE (STANDARD)

UL-50 UNITÉ
D'ENRUBANNAGE,
LARGEUR 50 MM.
(STANDARD)

UL-50 VERSCHLIESSEINHEIT,
MAX. KLEBEBANDBREITÉ
50 MM. (STANDARD)

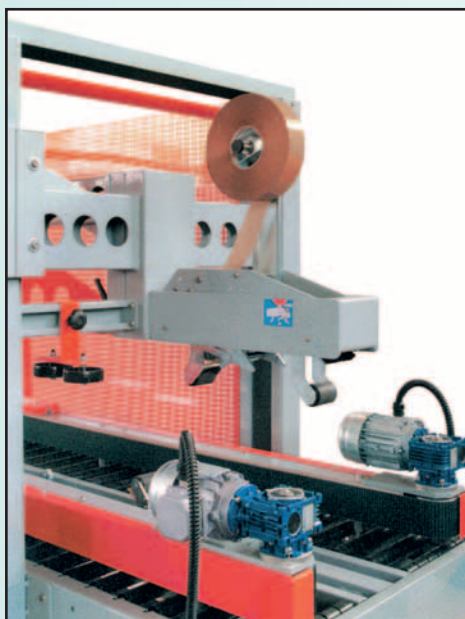

PROTEZIONI PERIMETRALI
CON FINECORSIA
DI SICUREZZA

SIDE SAFETY PROTECTIONS

GRILLES DE PROTECTION

UNFALLSCHUTZVORRICHTUNG

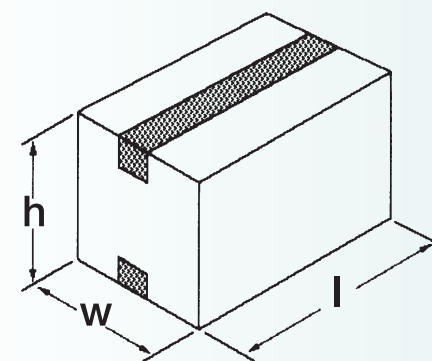

Dimensioni / Dimensions / Dimensions / Kartonformat (mm)

MOD.		UL-50		UL-75	
		Min.	Max.	Min.	Max.
SC1/500-MF	W	130	500	160	500
	H	130	500	130	500
	L	200	600	200	600
SC1/650-MF	W	130	650	160	650
	H	130	650	130	650
	L	200	600	200	600

UL-50 Unità nastrante, larghezza mm. 50

UL-75 Unità nastrante, larghezza mm. 75

UL-50 Unité d'enrubannage, largeur 50 mm.

UL-75 Unité d'enrubannage, largeur 75 mm.

UL-50 Taping head, 50 mm. wide

UL-75 Taping head, 75 mm. wide

UL-50 Verschliesseinheit, max. Klebebandbreite 50 mm.

UL-75 Verschliesseinheit, max. Klebebandbreite 75 mm.