

MYTHO



Tecnologia evoluta a servizio dell'uomo



ATLANTA
S T R E T C H



Atlanta Stretch S.p.A.

 ATLANTA STRETCH S.p.A è una azienda che si occupa di progettazione, costruzione e commercializzazione di macchine automatiche e semiautomatiche per l'avvolgimento dei pallet con il film estensibile.

Vantiamo una completa gamma di carrelli di prestiro motorizzati di ultima generazione per ottimizzare e ridurre il consumo di film estensibile per avvolgere i pallet.

Abbiamo adottato soluzioni tecniche che permettono di installare i sistemi con riduzione dei tempi e costi rispetto a macchine tradizionali, riduzione degli ingombri, facile accesso alle zone che richiedono manutenzione.

 ATLANTA STRETCH S.p.A is a company specialized in development, production and sales of semi-automatic and fully automatic stretch wrapping machines.

A range of evolved spool carriages with power stretch system of latest generation optimize and reduce stretch film consumption in pallet unitization.

We have introduced in the machines several technical solutions allowing their installation in reduced time and costs compared to traditional machines, reduction of space, easy access to area with maintenance needs.

 ATLANTA STRETCH S.p.A a pour activité la conception, la construction et la commercialisation de machines automatiques et semi automatiques pour le banderolage de charges palettisées par film étirable.

Nous pouvons nous vanter d'une gamme complète de chariots de pré étirage motorisés et asservi de dernière génération pour optimiser et réduire la consommation de film étirable.

Nous avons adopté des solutions techniques qui permettent d'installer très facilement notre matériel avec une réduction importante des temps de montage par rapport aux machines traditionnelles.

Nous avons également travaillé sur la réduction des encombrements et sur la facilité d'accès aux zones d'entretien.

 ATLANTA STRETCH S.p.A ist ein Unternehmen, das im Bereich der Verpackung und Transportsicherung tätig ist.

Der Schwerpunkt des Unternehmens liegt in der Entwicklung, Konstruktion und Vertrieb von halb- und vollautomatischen Wicklern für Stretchfolie.

Weiter können wir eine Reihe motorisierter Vordehnsysteme der letzten Generation aufweisen, dies ermöglicht den Folienverbrauch sowie die Verpackungskosten zu senken. Hierbei wurde besonders auf eine kompakte Bauweise geachtet um die Installationszeit zu verkürzen, Kosten einzusparen und eine einfache Zugänglichkeit zu ermöglichen um die notwendigen Wartungsarbeiten durchzuführen.

 ATLANTA STRETCH S.p.A es una empresa que se dedica de la proyectación, construcción y comercialización de máquinas automáticas y semiautomáticas para el envolvimiento de los palets con film extensible.

Son máquinas patentadas por su exclusividad.

Tenemos una completa gama de carros de pre-estiro motorizados de última generación, para optimizar y reducir el consumo del film extensible para envolver el palet.

Hemos adoptado soluciones técnicas que nos permite su instalación con reducción de coste y tiempo con respecto a las máquinas tradicionales, reducción del espacio, fácil acceso a las zonas que requieren mantenimiento.

Il sistema Mytho Mytho system



- 🇮🇹 Grazie al minimo ingombro mi trasportano facilmente con costi ridotti e sto ovunque.
- 🇬🇧 Thanks to my compact size I can be shipped economically and I fit anywhere.
- 🇫🇷 Grâce au moindre encombrement, il se transporte facilement avec des coûts réduits et il peut être positionné partout.
- 🇩🇪 Einfach zu transportieren und in jeder Stelle zu platzieren dank der kompakten Bauweise.
- 🇪🇸 Gracias al mínimo espacio, facilita el transporte con un reducido coste.



I vecchi sistemi Old systems



- 🇮🇹 I sistemi tradizionali sono più ingombranti.
- 🇬🇧 Traditional systems take up more space.
- 🇫🇷 Les systèmes traditionnels sont plus encombrants.
- 🇩🇪 Die konventionelle Systeme brauchen mehr Platz.
- 🇪🇸 Los sistemas tradicionales son más voluminosos.

- 🇮🇹 Non necessita di manutenzione.
- 🇬🇧 I don't need maintenance.
- 🇫🇷 Il ne requiert aucun entretien.
- 🇩🇪 Reduzierte Wartungskosten.
- 🇪🇸 No necesita de mantenimiento.



- 🇮🇹 I sistemi tradizionali necessitano di manutenzione e usano meccanismi che vanno regolati e ingrassati.
- 🇬🇧 Traditional systems need maintenance and use mechanisms that require adjusting and lubricating.
- 🇫🇷 Les systèmes traditionnels nécessitent un entretien et ils utilisent des mécanismes qui doivent être graissés et réglés.
- 🇩🇪 Die konventionelle Systeme brauchen regelmäßige Wartung, Einstellung und Schmierung.
- 🇪🇸 Los sistemas tradicionales necesitan de mantenimiento y usan mecanismos guiados y engrasados.

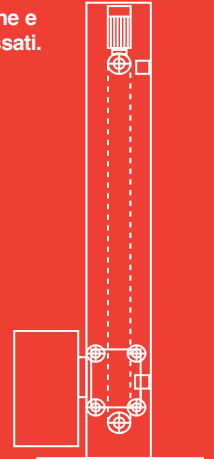

- 🇮🇹 Inserisco il film estensibile con facilità e ne consumo poco.
- 🇬🇧 I easily insert stretch film and I use it economically.
- 🇫🇷 Facilité de passage du film en sécurité et consommation réduite.
- 🇩🇪 Schnelle Einführungssystem und sparsame Verbrauch von Stretchfolien.
- 🇪🇸 Introducción del film extensible con facilidad y reducido tiempo.







- 🇮🇹 I sistemi tradizionali sono pericolosi, poco rapidi e dispendiosi.
- 🇬🇧 Traditional systems are dangerous, slow and costly.
- 🇫🇷 Les systèmes traditionnels sont dangereux, plus lents et plus onéreux.
- 🇩🇪 Die konventionelle Systeme sind gefährlich, langsam und teuer.
- 🇪🇸 Los sistemas tradicionales son más peligrosos, poco rápidos y costosos.

- 🇮🇹 Non necessita di installazione.
- 🇬🇧 I don't need to be installed.
- 🇫🇷 Il ne nécessite aucune installation.
- 🇩🇪 Reduzierte Inbetriebnahmekosten.
- 🇪🇸 No necesita de instalación.



- 🇮🇹 Nei sistemi tradizionali l'albero con catena va montato durante installazione.
- 🇬🇧 In traditional systems, the mast with chain must be mounted during installation.
- 🇫🇷 Sur les systèmes traditionnels le mat doit être monté.
- 🇩🇪 In der konventionellen Systeme der Mast mit Kette wird bei Inbetriebnahme aufgestellt.
- 🇪🇸 En los sistemas tradicionales el eje con cadena se monta durante la instalación.

MYTHO

-  Tavola rotante di nuova generazione per avvolgere carichi palletizzati di qualsiasi forma e peso con film estensibile anche macroforato.
-  Stretchwickler der neuen Generation zum Wickeln von Ladungen unterschiedliche Formen und Gewichte mit Stretchfolien oder gelochte Stretchfolien.
-  Mesa rotante de nueva generación para envolver cargas paletizadas de cualquier forma y peso, con film extensible y macro perforado.
-  New design turntable for wrapping palletised loads of any shape and weight with stretchable film, including macro-holed film.
-  Table tournante de dernière génération pour filmer les charges palettisées avec du film étirable plein ou macro perforé.

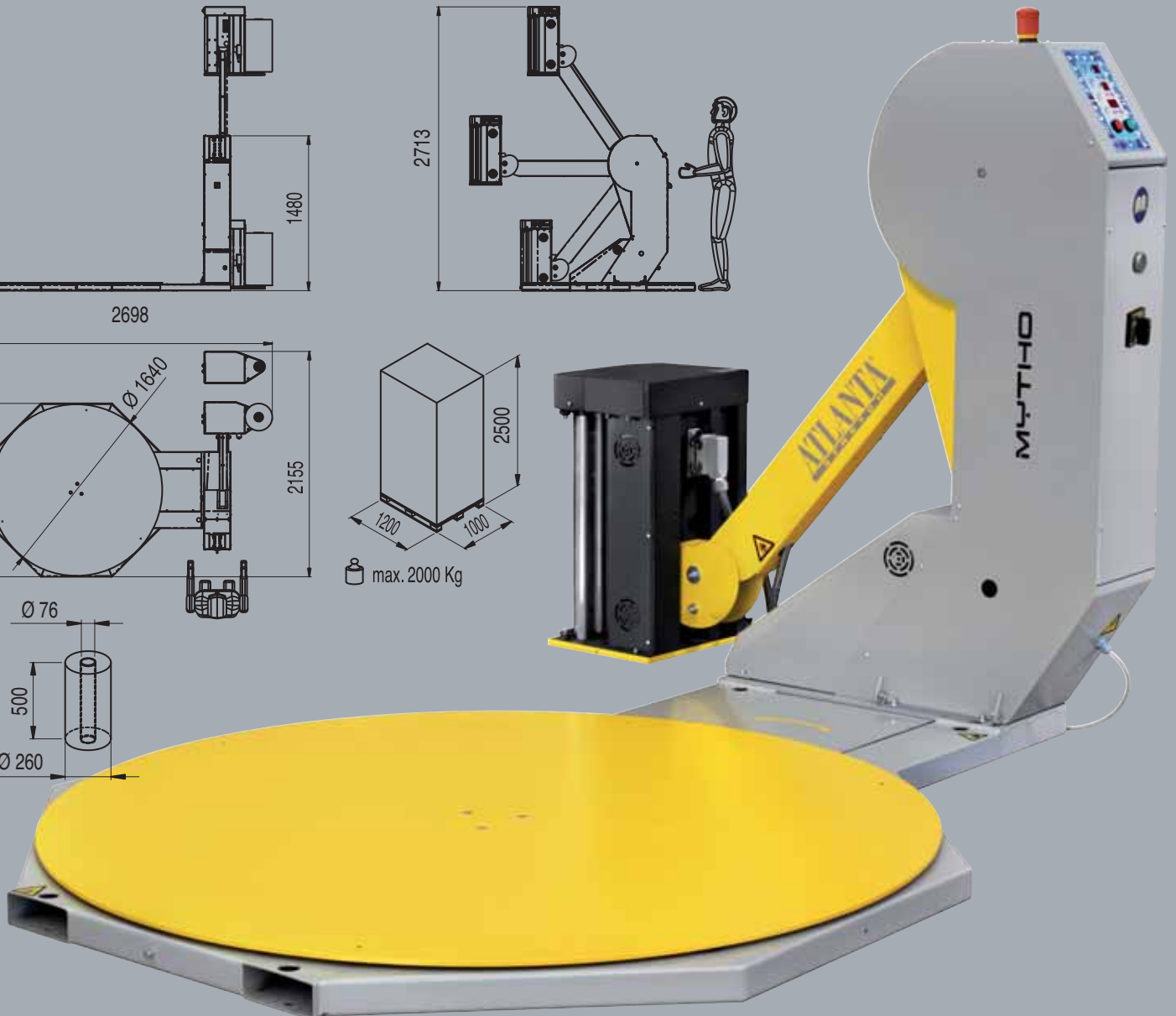
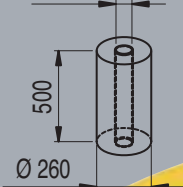
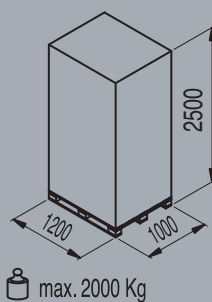
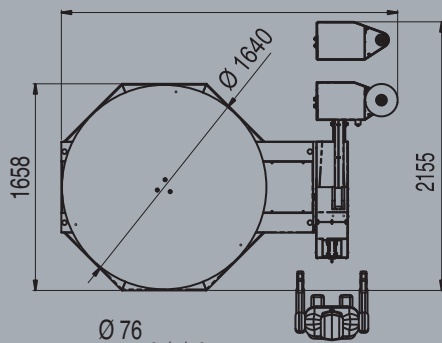
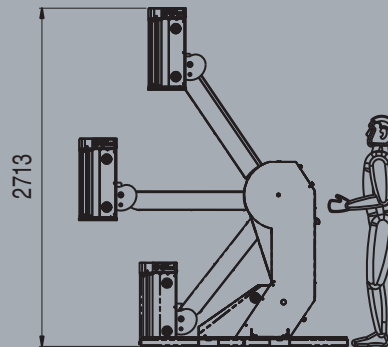
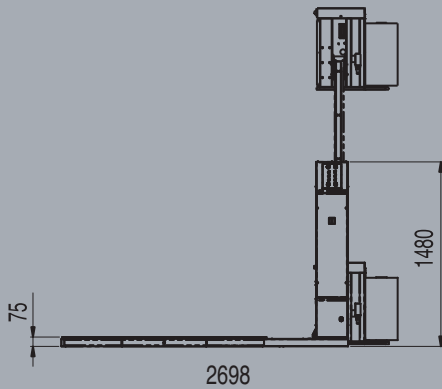
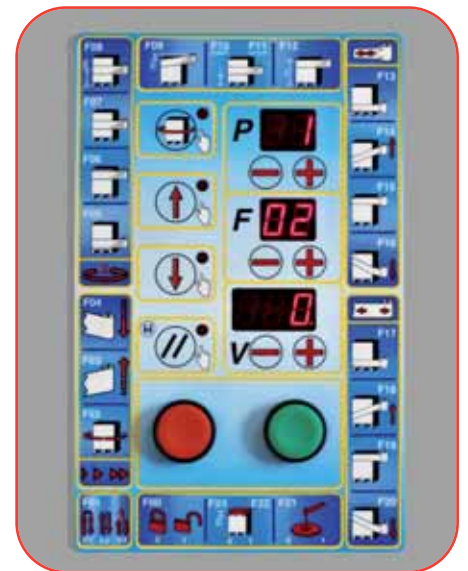

MYTHO TP

 Versione transpallet.

 Transpallet version.

 Version transpalette.

 Ausführung Transpallet.

 Version transpalet.

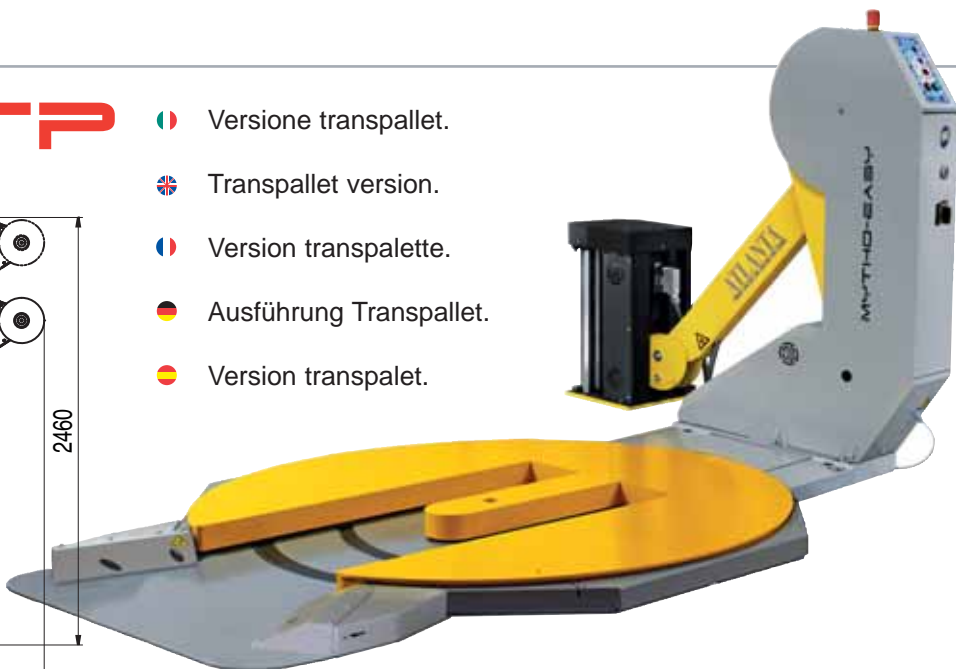
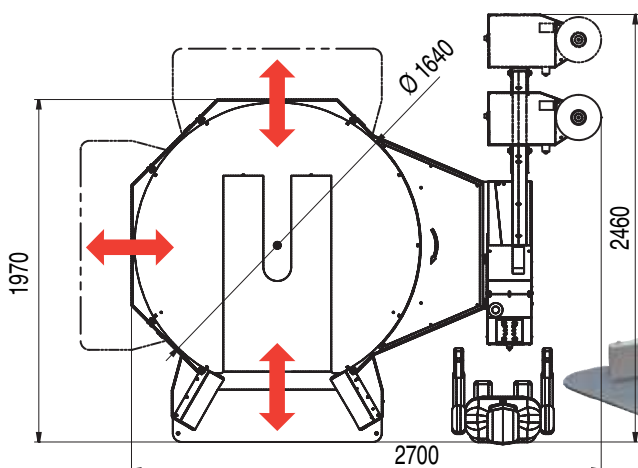

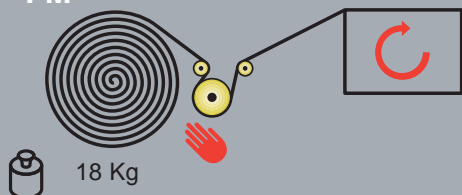

FM





 Freno meccanico regolabile manualmente

 Frein mécanique sur rouleau de détour ajustable manuellement.

 Fricción mecánica regulable manualmente.

 Mechanical brake manually adjustable.

 Mechanische Bremse auf Umlenkwalze.

 18 Kg

FE

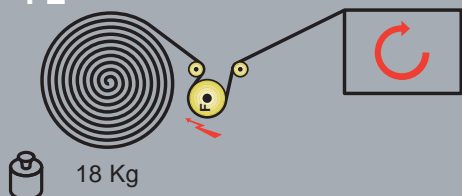



 Frizione elettromagnetica regolabile da pannello comandi.

 Frein électro magnétique sur rouleau de détour ajustable au pupitre de commandes.

Umlenkwalze vom Bedienpult einstellbar.

 Electromagnetic friction adjustable from control panel.

 Elektromagnetische Bremse auf

 Fricción electromagnética regulable desde el panel de comandos.

 18 Kg

PRS POWER ROLLER STRETCH

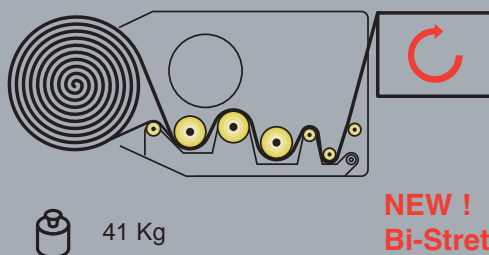



 Sistema di prestiro motorizzato a 3 rulli comandato elettronicamente con rapporti intercambiabili: 150 - 200 - 250 %.

 Système de pré-étirage à 3 rouleaux motorisés avec asservissement électronique et rapports facilement interchangeables 150 - 200 - 250%

wechselbarer Zahnradsätzen: 150 - 200 - 250%.

 Motorized pre-stretch system with 3 driven rollers electronically controlled with interchangeable ratios: 150 - 200 - 250%

 Angetriebener Vordehnsystem mit 3 Vordehnrollen, elektronisch gesteuert mit leicht

 Sistema de prestiro motorizado con 3 rodillos, comandado electrónicamente con desarrollos intercambiables: 150 - 200 - 250%.

 41 Kg

**NEW !
Bi-Stretch**

PS POWER STRETCH

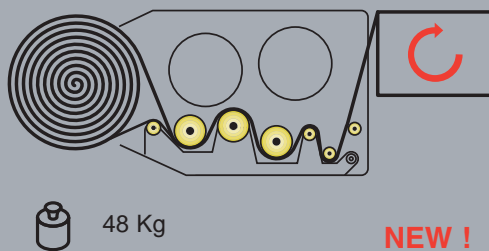



 Sistema di prestiro motorizzato a 3 rulli con 2 motori e variazione continua da 120 a 350% regolabile da quadro comandi.

 Système de pré-étirage à 3 rouleaux motorisés avec asservissement électronique et rapport ajustable au pupitre de commandes de 120 à 350 % par 2 moteurs.

regelbare Werte zwischen 120 und 350% von Bedienpult.

 Motorized pre-stretch system with 3 driven rollers and 2 motors adjustable between 120 to 350% from control panel.

 Angetriebener Vordehnsystem mit 3 Vordehnrollen und 2 Motoren, stufenlos

 Sistema de prestiro motorizado con 3 rodillos y 2 motores, regulable da 120 a 350% desde el panel de comandos.

 48 Kg

**NEW !
Bi-Stretch**

MYTHO EASY

NEW

-  Con Mytho-Easy (facile da usare), si completa la gamma di macchine, questa versione si caratterizza per le funzioni semplificate. Pannello di controllo multifunzione programmabile.
-  The easy-to-use Mytho-Easy completes our range of machines; this version features simplified operation. Multifunction programmable control panel.
-  Mytho-Easy (utilisation facile) se caractérise pour l'utilisation et l'application de film pré-étiré et par ses fonctions simples mais complètes.

Panneau de contrôle multifonction programmable.

-  Mytho-Easy (Einfach zum Bedienen) ergänzt die Baureihe der Stretchwickler, das Merkmal dieses Modell ist die Vereinfachung der Funktionen. Multifunktion programmierbare Systemsteuerung.

-  Con Mytho-Easy (facil da usar), se completa la gama de maquinas, esta versión se caracteriza por las funciones simplificadas. Panel de control programable multifunción.



Parametri facilmente regolabili tramite pannello.

- Velocità di rotazione tavola.
- Salita e discesa carrello.
- Programmazione separata giri alti e bassi.
- Fotocellula lettura altezza pallet.
- Ciclo salita / salita e discesa.
- Ciclo mettifoglio.
- Cicli manuali: Rotazione tavola, Salita e discesa carrello portabobina.





Parameters easily adjustable from the panel.

- Table rotation speed.
- Carriage ascent and descent.
- Separate programming for high and low rpm.
- Pallet height photoelectric cell reading.
- Ascent / Ascent and Descent cycle.
- Sheet placement cycle.
- Manual cycles: Table rotation, Roll carriage ascent and descent.

Paramètres ajustables au pupitre.

- Vitesse de rotation de la table
- Vitesse de déplacement du chariot
- Tours droits haut et bas séparés
- Débordement supérieur du film
- Cycle montée et descente
- Cycle montée et descente seule
- Cycle dépose de coiffe
- Cycles manuels: Rotation table Montée/arrêt du chariot
- Descente /arrêt du chariot.



-  Rampia di carico.
  Ladungsrampe.
-  Loading ramp.
  Rampa de carga.
-  Rampe.

Einstellbare Parameter von Bedienungstafel.

- Stufenlos regelbare Drehtellergeschwindigkeit.
- Stufenlos regelbare Hubschlittengeschwindigkeit.
- Einstellbare Anzahl für Fuß- und Kopfwicklungen.
- Fotozelle zur selbständigen Höhenabfrage.
- Kreuzspiral und Spiral.
- Regendichtprogramm.
- Manueller Zyklusablauf: Drehtellerdrehung. Hubschlitten Auf- und Abwärts.

Parámetros de fácil regulación mediante panel.

- Velocidad de rotación de la mesa.
- Subida y bajada carro.
- Programacion separada de vueltas altas y bajas.
- Fotocelula lectura altura palet.
- Ciclo subida/subida y bajada.
- Ciclo metefolio.
- Ciclos manuales: Rotacion mesa. Subida y bajada carro porta bobina.



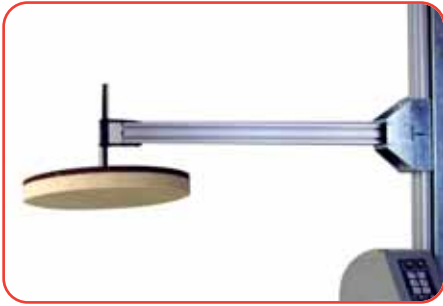

- Pressore tenuta pallet.
- Pallet holder presser.
- Plateau stabilisateur de charge.
- Palettendruckhalter.
- Prensor retención palet.



- Colonna per carichi fino a 3300 mm.
- Mast for loads up to 3300 mm high.
- Colonne pour charges jusqu'à 3300 mm.
- Mast für Ladungen bis 3300 mm hoch.
- Columna para cargas de hasta 3300 mm.



- Rulliera non motorizzata.
- Non-motorized roller conveyor.
- Non-motorisés à rouleaux.
- Nicht-Motorisierte Rollenbahn.
- Rodillos no motorizados.



- Sistema di pesatura integrato.
- Integrated weighing systems.
- Pesage intégré.
- Integrierte Waagesysteme.
- Sistema integrado de pesaje.



- Sistema d'imballo per porte e finestre.
- Wrapping System for doors and windows.
- Système d'emballage pour portes et fenêtres.
- Wickelsysteme für Fenster und Türen.
- Sistema de embalaje para puertas y ventanas.



- Sistema di taglio automatico del film a fine ciclo.
- Automatic Film cutting device at cycle end.
- Coupe automatique du film.
- Automatische Folienschneidvorrichtung am Zyklusende.
- Sistema automático de corte film con fin de ciclo.



- Controllo peso film.
- Film weight check.
- Calcul poids de film.
- Kontrolle Foliengewicht.
- Control peso film.

ON REQUEST, INOX OR FREEZER (-30°) VERSIONS.

Dati Tecnici

	MYTHO/MYTHO EASY	MYTHO/MYTHO EASY - TP
Potenza totale installata	1.00 Kw	1.00 Kw
Tensione alimentazione standard	230V monofase - 50/60 Hz - 6A	230V monofase - 50/60 Hz - 6A
Protezione impianto elettrico e motori	IP 54	IP 54
Dimensione max pallet	1000 x 1200 mm	1000 x 1200 mm
Altezza std pallet	2500 mm	2500 mm
Portata max	2000 Kg	1200 Kg
Diametro tavola	1640 mm	1640 mm

Technical Characteristics

	MYTHO/MYTHO EASY	MYTHO/MYTHO EASY - TP
Total installed power	1.00 Kw	1.00 Kw
Standard input voltage	230V mono-phase - 50/60 Hz - 6A	230V mono-phase - 50/60 Hz - 6A
Electrical system and motors protection	IP 54	IP 54
Max pallet dimensions	1000 x 1200 mm	1000 x 1200 mm
Standard pallet height	2500 mm	2500 mm
Max capacity	2000 Kg	1200 Kg
Table diameter	1640 mm	1640 mm

Données Techniques

	MYTHO/MYTHO EASY	MYTHO/MYTHO EASY - TP
Puissance totale installée	1.00 Kw	1.00 Kw
Tension alimentation standard	230V mono-phase - 50/60 Hz - 6A	230V mono-phase - 50/60 Hz - 6A
Protection installation électrique et moteurs	IP 54	IP 54
Dimensions maximum palette	1000 x 1200 mm	1000 x 1200 mm
Hauteur standard palette	2500 mm	2500 mm
Portée maximum	2000 Kg	1200 Kg
Diamètre de la table	1640 mm	1640 mm

Technische Daten

	MYTHO/MYTHO EASY	MYTHO/MYTHO EASY - TP
Gesamte Leistung	1.00 Kw	1.00 Kw
Anschluss-Spannung	230V mono-phase - 50/60 Hz - 6A	230V mono-phase - 50/60 Hz - 6A
Elektroanlage und Motore Schutzart	IP 54	IP 54
Max. Palettenabmessung	1000 x 1200 mm	1000 x 1200 mm
Max. Standard Wickelhöhe	2500 mm	2500 mm
Max. Ladungsgewicht	2000 Kg	1200 Kg
Drehteller Durchmesser	1640 mm	1640 mm

Datos Técnicos

	MYTHO/MYTHO EASY	MYTHO/MYTHO EASY - TP
Potencia total instalada	1.00 Kw	1.00 Kw
Tension de alimentacion estandar	230V mono-phase - 50/60 Hz - 6A	230V mono-phase - 50/60 Hz - 6A
Proteccion montaje electrico y motores	IP 54	IP 54
Dimension max palet	1000 x 1200 mm	1000 x 1200 mm
Altura estandar palet	2500 mm	2500 mm
Peso max	2000 Kg	1200 Kg
Diametro mesa	1640 mm	1640 mm

SYNTHESI



SFERA



MYTHO-A



REVOLUTION



OMEGA



ATLANTA
STRETCH

ATLANTA STRETCH S.p.A
Via Chiesa di Camerano, 30
47824 Poggio Berni (Rimini)
ITALIA

Tel. +39 0541 627145
Fax +39 0541 627220
www.atlantastretch.com
sales@atlantastretch.com

Atlanta Deutschland GmbH
Atlanta Stretch Sweden AB
Atlanta Packaging SA - Spain
Atlanta Packaging Ltd - UK
Atlanta France Sarl
Atlanta Packaging Systems Australasia